

HONEYWELL

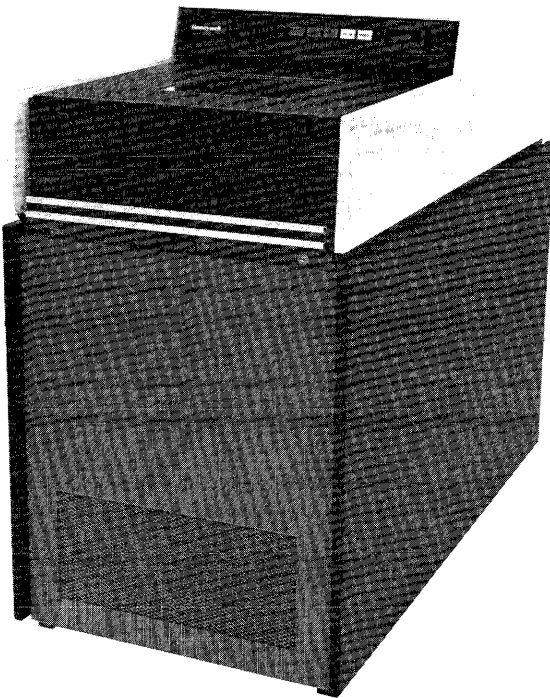

LARGE SYSTEMS

MSU0402/0451

MASS

STORAGE UNITS

OPERATION

HARDWARE

Large Systems MSU0402/MSU0451 Mass Storage Units Operation

SUBJECT

General Description, Operation, and Maintenance Procedures for the MSU0402/MSU0451 Mass Storage Units and their Mass Storage Processors

SPECIAL INSTRUCTIONS

This edition supersedes AT71-02, dated October 1977, and its addenda, AT71-02A, dated December 1980, and AT71-02B, dated July 1982. This manual has been extensively revised; therefore, change indicators are not used.

The following notice is provided in accordance with the United States Federal Communications Commission's (FCC) regulations.

Warning: This equipment generates, uses, and can radiate radio frequency energy and if not installed and used in accordance with the instructions manual, may cause interference to radio communications. As temporarily permitted by regulation it has not been tested for compliance with limits for Class A computing devices pursuant to Subpart J of Part 15 of FCC Rules, which are designed to provide reasonable protection against such interference. Operation of this equipment in a residential area is likely to cause interference in which case the user at his own expense will be required to take whatever measures may be required to correct the interference.

ORDER NUMBER

AT71-03

October 1982

Honeywell

About This Manual

This reference document provides hardware-oriented descriptive and instructive material for the user of the MSU0402/MSU0451 Mass Storage Units and for others concerned with their technical aspects, application, or use.

Divided into three sections and an appendix, this manual contains a general description of the hardware used in the subsystem, including performance specifications, capabilities, features, and options (Section 1); a description of the operator-accessible control panel switches and indicators (Section 2); the operating procedures necessary to enable personnel to operate the units and maintenance procedures (Section 3); and mass storage processor information in the appendix.

Honeywell disclaims the implied warranties of merchantability and fitness for a particular purpose and makes no express warranties except as may be stated in its written agreement with and for its customer.

In no event is Honeywell liable to anyone for any indirect, special or consequential damages. The information and specifications in this document are subject to change without notice.

Contents

Section 1. Introduction

Data Integrity and Protection	1-1
Improved System Availability	1-2
Options	1-2
Characteristics	1-2
Disk File Format Consideration	1-2
Intermixing	1-3

Section 2. Controls and Indicators

Section 3. Operating Procedures

Power-Up Sequence	3-1
Power-Down Sequence	3-1
Initialization	3-2
Disk Pack Loading	3-2
Disk Pack Unloading	3-3
Unit Select Plug Swapping	3-3
Disk Pack Handling and Storage	3-4
General Cleaning	3-4

Appendix. Mass Storage Processors

Components	A-1
Mass Storage Subsystem Configurations	A-5
Controls and Indicators	A-8

Figures

2-1 MSU0402/0451 Control Panel	2-2
A-1 Mass Storage Processor Components	A-2
A-2 Integrated Mass Storage Processor Control Panel	A-8
A-3 Freestanding Mass Storage Processor Control Panel	A-8

Tables

1-1	Mass Storage Unit Characteristics	1-3
3-1	Preventive Maintenance	3-4
A-1	Mass Storage Processors for MSU0402/0451	A-2
A-2	Mass Storage Processor Options	A-3
A-3	MSP0602/0603 Mass Storage Processor Configurations	A-5
A-4	MSP0605 Mass Storage Processor Configurations	A-6
A-5	MSP0604/0607/8000/8001 Mass Storage Processor Configurations	A-6
A-6	MSP0609 Mass Storage Processor Configurations	A-7
A-7	MSP0611 Mass Storage Processor Configurations	A-7
A-8	MSP0612 Mass Storage Processor Configurations	A-7
A-9	Mass Storage Processor Controls and Indicators	A-8

Section 1

Introduction

The MSU0402/MSU0451 Mass Storage Units are high-capacity disk storage sub-systems with advanced microprogrammed control and operating features that improve response time and throughput. The MSU0402 is identical in appearance and operation to the MSU0451 and may be field-upgraded (see Options) to an MSU0451. Up to 32 of these disk units per mass storage processor can be connected to any Large System. The disk units are controlled by physically integrated or freestanding mass storage processors (described in Appendix A).

Data Integrity and Protection

The integrity and protection of data is ensured by the following features:

- *Write protect capability* – Individual write-protect push button for each disk unit excludes the possibility of recording on protected files.
- *Automatic unloading* – Heads automatically unload when specific conditions, such as low rotational speed or loss of power, are detected.
- *Power fault sensing* – If an ac or dc power fault has occurred, recording cannot take place.
- *Write current monitoring* – Write current is inhibited during seeks or without command and loss is detected during a write command.
- *Check code insertion* – The validity of recorded information is ensured by the insertion of characters of check information (“check code”) in each record.
- *Parity checking* – The device monitors command and data lines for odd parity; if even parity is detected, a fault is set.
- *Temperature sensing* – Temperatures greater than equipment specifications are displayed and an audible alarm sounded.
- *Head offset* – Heads may be offset by command to facilitate data recovery.
- *No/multihead select* – The device checks for no/multiheads being selected, which will produce a fault condition.

Improved System Availability

An enhanced diagnostic ability reduces both system time required for online repair and the total offline repair time spent on the unit itself. Online error and status reporting to the central processor system allows software-controlled diagnosis of the electronics.

Options

- MSF0006 — Dual access capability
- MSF0007 — Rotational position sensing (required)
- MSK4025 — Upgrade kit for MSU0402 to MSU0451

Characteristics

Table 1-1 lists the operational characteristics of both devices.

The physical characteristics are:

- *Height* – 39.2 in. (99.7 cm)
- *Width* – 22.0 in. (55.9 cm)
- *Depth* – 44.5 in. (113.0 cm)
- *Weight* – 680 lb (309 kg)

The Honeywell M4451 disk pack (or equivalent) can be removed from the unit, stored, and inserted as the need arises. For supplies and accessories order information, refer to the Honeywell *Computer Supplies Catalog*, Order No. BY62, or consult your Honeywell Marketing Representative.

Disk File Format Consideration

Physically, the MSU0402 and MSU0451 disk packs are the same. The logical file formats for labels, T&Ds, and alternate track locations are different, therefore, disk pack files cannot be interchanged between the MSU0402 and MSU0451. The M4451 disk pack used on the MSU0402 requires reformatting prior to use on a MSU0451.

Table 1-1. Mass Storage Unit Characteristics

Characteristics	MSU0402	MSU0451
Data capacity. Formatted (millions 6-bit characters/ millions 9-bit bytes)	117/78	235/156
Transfer rate (thousands 6-bit characters per s/ thousands 9-bit bytes per s)	1074/716	1074/716
Bit density (bpi)	4040	4040
Track density (tpi)	384	384
Average access time (ms)	33.3	38.3
Minimum seek time (ms)	8.0	8.0
Average seek time (ms)	25.0	30.0
Maximum seek time (ms)	45.0	55.0
Average latency (ms)	8.3	8.3
Simultaneity	During data transfer on one unit, a simultaneous seek operation can be performed on all other units on the same mass storage processor.	
Disks per pack	12	12
Recording surfaces per pack	19	19
Tracks per recording surface	411	815
(spares included)	7	7
Spindle speed (rpm)	3600	3600
Disk pack used (or equivalent)	M4451	M4451

Intermixing

Mass storage processors for all Large Systems (Table A-1) have been designed to allow MSU0400 and MSU0451 units or MSU0402 and MSU0451 units to be intermixed on the mass storage processors. (See Tables A-3 through A-8.) MSU0400 and MSU0402 units cannot be intermixed.

The advantages of this capability are as follows:

- Eases conversion to MSU0451. Installation of MSU0451s can be staggered, one or two at a time, minimizing system disruption.

- Combines the lower price-per-character advantage of the MSU0451 with the performance advantage (faster access time) of the MSU0400. Storing of a smaller number of files on the MSU0400 also results in less arm contention to high-activity files.
- Allows continued use of previously purchased disk packs. The smaller-capacity, less-expensive MSU0400 disk pack can be used as removable media during new program and file debugging.

The MSU0402/0451 can also be intermixed with MSU0500. Additionally, MSU0451 can be intermixed with MSU0501. (See Tables A-3 through A-8.)

Section 2

Controls and Indicators

Primary power is controlled by the MAIN POWER circuit breaker located inside the rear door of the unit. The controls and indicators on the control panel for the MSU0402 and MSU0451 are shown in Figure 2-1.

A description of the function of each indicator and control follows:

START/STOP

This push button/indicator is used to start and stop spindle rotation. When lighted (red), it indicates that power is applied to the spindle motor. If pressed when lighted, it causes the spindle to come to a stop and the indicator light goes out.

READY

This indicator lights (green) when the spindle is rotating at proper speed, the heads are loaded, and the unit is ready to accept commands.

CHECK

This push button/indicator lights (red) when a fault condition has occurred or the air flow is insufficient. After correcting the problem, press the button to clear the fault registers and reset the indicator.

OFFLINE

This indicator lights (white) when the unit is in the offline mode. The unit may be placed offline by setting the OFFLINE switch on the maintenance panel behind the rear door of the unit.

PROTECT

This push button/indicator is used to inhibit or enable write operations on the disk pack. When the PROTECT indicator is lighted (yellow), pressing it will turn the light off and enable write operations. When the PROTECT indicator is off, pressing it will turn it on and inhibit write operations.

UNIT SELECT PLUG

When inserted, the unit select plug determines the physical identifier number (1-32) transmitted by command to the mass storage processor. When the plug is removed, the number zero is transmitted.

Note: The uncoded unit select plug supplied with each unit must be encoded by Honeywell Customer Services during installation. Once encoded, the number of the plug may not be changed. Additional uncoded plug kits are available as an accessory. Plugs may be interchanged among units.

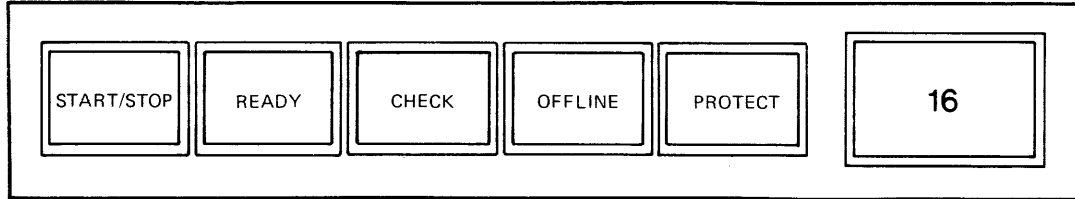

Figure 2-1. MSU0402/0451 Control Panel

Section 3

Operating Procedures

Power-Up Sequence

In the following procedure, it is assumed that all cables have been properly connected and secured and that power is supplied to the unit.

1. Open the rear door.
2. Set the MAIN POWER circuit breaker to the ON position.
3. Close the rear door.
4. A disk pack may be loaded.

Power-Down Sequence

1. Press the START/STOP button to bring the unit to a stop.

WARNING

To avoid personal injury after initiating disk unit cycle down, you must: wait 30 seconds before lifting the disk pack access cover; then visually verify that disk pack rotation has stopped before accessing the disk pack area.

2. Open the cover and remove the disk pack.
3. Close the cover.
4. Open the rear door.
5. Set the MAIN POWER circuit breaker to the OFF position.
6. Close the rear door.

Initialization

To initialize a unit, press the CHECK button on the control panel. This resets all operational and status registers.

Disk Pack Loading

Make certain that the disk pack to be mounted has been cleaned and maintained properly.

1. Verify that the START/STOP indicator is not lighted.

CAUTION

Never attempt to open the cover when START/STOP is lighted as this will cause the heads to unload and the spindle to stop.

2. Open the cover.
3. Lift the disk pack by the plastic canister handle.
4. Disengage the bottom dust cover from the disk pack using the knob in the center of the cover. Set the cover aside to a dust-free storage area.

CAUTION

Avoid abusive contact between the disk pack and the spindle. Make certain that the heads are fully retracted.

5. Place the disk pack onto the spindle.
6. Twist the canister handle clockwise until the slip clutch resists further twisting. The pack is now locked in place.
7. Lift the canister clear of the disk pack and set it on the bottom of the dust cover.
8. Close the cover immediately to prevent dust from getting in and contaminating the disk surfaces.
9. Insert the unit select plug with the appropriate physical identifier number into the slot.
10. Select one of the following procedures as appropriate.
 - To *enable* writing on the disk pack, *do not* press the PROTECT button (leave it unlit).
 - To *inhibit* writing on the disk pack, press the PROTECT button (PROTECT lights up).
11. Press the START/STOP button. START/STOP and READY light up.

Disk Pack Unloading

1. Press the START/STOP button to stop spindle and pack rotation. The START/STOP indicator extinguishes.

WARNING

To avoid personal injury after initiating disk unit cycle down, you must: wait 30 seconds before lifting the disk pack access cover; then visually verify that disk pack rotation has stopped before accessing the disk pack area.

2. Open the cover.

CAUTION

During maintenance procedures the read/write heads sometimes are positioned manually. Make certain that the heads are fully retracted.

3. Place the plastic canister over the mounted disk pack so that the post protruding from the center of the disk pack is received into the canister handle.
4. Twist the canister handle counterclockwise until the disk pack is free of the spindle.
5. Lift the canister and the disk pack clear of the spindle.
6. Close the cover.
7. Place the bottom dust cover in position on the disk pack and tighten it.
8. Store the disk pack in a clean cabinet or on a clean shelf.

Unit Select Plug Swapping

The removable unit select plugs allow the operator to easily change physical addresses simply by swapping the plugs among devices.

The operator should maintain a log of all device address swaps (device, from/to, date and time, reason for change) so that the MSP diagnostic output and the associated problem can be related to the correct physical device. These problem history procedures reduce confusion on sites with large peripheral configurations.

Disk Pack Handling and Storage

The following common sense rules are the prerequisites for proper disk pack handling:

- Always keep a disk pack in its carrying case whenever it is not on a disk pack drive.
- The bottom cover of the disk pack carrying case may be removed easily by squeezing the latch on the bottom cover; the top cover is designed so that it cannot be removed until the disk pack is mounted on the spindle.
- Always reassemble the disk pack carrying case covers even when the disk pack is not inside.
- Never touch disk pack recording surfaces or the spindle mating surface with anything.
- Do not expose a disk pack to stray magnetic fields, excessive pressure, or sharp impact.
- Return every disk pack to its own carrying case.
- Never store a disk pack where the temperature exceeds the limit of 60°F-90°F (15°C-32°C). If the limit has been exceeded, keep the disk pack in the operating room temperature for two hours before it is used.
- Store a disk pack in an environment identical to the disk pack drive operating environment.
- Never store a disk pack near strong magnetic fields or in direct sunlight.
- Store a disk pack flat, resting on its bottom cover. Never store a disk pack on edge.

General Cleaning

Operators should keep cabinets clean and free of dust. The disk pack chamber and spindle may be cleaned with a lint-free industrial cleaning tissue lightly dampened with an approved cleaning alcohol.

Table 3-1 summarizes the operator maintenance procedures and schedule.

Table 3-1. Preventive Maintenance

Procedure	Schedule	Time
Clean pack cover glass	Quarterly or every 1500 hours	1 min.
Replace primary filter	Quarterly or every 1500 hours	10 min.
Clean shroud and spindle	Semiannually or every 3000 hours	1 min.

Appendix

Mass Storage Processors

The mass storage processors for the MSU0402/0451 are microprogrammed peripheral processors that connect to the central processor via high-speed I/O channels and relieve the central processor system of all device-oriented functions. The mass storage processors for the MSU0402/0451 are listed in Table A-1.

Components

The mass storage processors consist of the following components (see Figure A-1).

- *Read-Only Memory* – provides access and storage to resident control and diagnostic microprograms.
- *Microprocessor* – interprets all the microinstructions and performs their specified operations.
- *Scratchpad memory* – provides temporary storage for data buffering parameters and command storage.
- *Peripheral Subsystem Interface (PSI) Control* – provides the logic and buffering necessary to interface with the one-byte-wide PSI to sustain data transfer and control dialogs.
- *Device Level Interface (DLI) Control* – provides the logic and buffering necessary to interface with DLIs to sustain data transfers and control dialogs in addition to verification information generation and checking.

The options available for the mass storage processors are listed in Table A-2.

Table A-1. Mass Storage Processors for MSU0402/0451

Marketing Identifier	Description
MSP0602	Integrated mass storage processor for MSU0400/0402/0451/0500/0501
MSP0603	Freestanding mass storage processor for MSU0400/0402/0451/0500/0501
MSP0604	Integrated single-channel mass storage processor for DPS ICU systems
MSP0605	Integrated mass storage processor for MSU0402/0451/0500/0501 (66/05 systems only)
MSP0607	Freestanding single-channel mass storage processor for DPS systems
MSP0608	Dual-channel mass storage processor for DPS ICU systems
MSP0609	Freestanding dual-channel mass storage processor for DPS systems
MSP0611	Freestanding single-channel mass storage processor for DPS systems
MSP0612	Freestanding dual-channel mass storage processor for DPS systems
MSP8000	Integrated single-channel mass storage processor for CPS8123/24/26/27/28 systems
MSP8001	Dual-channel mass storage processor for CPS8124/26/27 systems

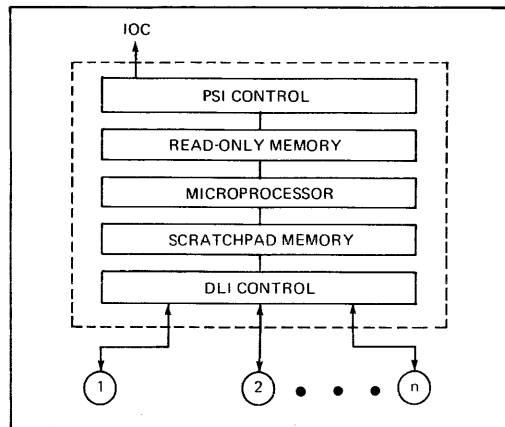

Figure A-1. Mass Storage Processor Components

Table A-2. Mass Storage Processor Options

Mass Storage Processor	Option	Description
MSP0602/0603	MSF1024	Device Adapter for MSU0500
	MSF1025	Device Adapter for MSU0501/0500 When no MSU500s are present on a MSP0602/0603, the MSF1025 Device Adapter must be ordered to configure MSU0501s, or MSU0500s and MSU0501s in combination. If only MSU0500 is configured, order MSF1024.
	MSF1028	Dual Simultaneous Channel used when no MSU0500/0501s are configured
	MSF1033	Drive Expansion for more than 16 MSU0400/0402/0451 single-channel units
	MSF1035	Device Adapter for MSU0402/0451
	MSF1036	Dual Processor Crossbar (one per two processors)
	MSF1045	MSU0501 Attachment Feature with MSU0500 Device Adapter (MSF1024) installed
MSP0602/0603/0605	MSF1019	Nonsimultaneous IOM/DATANET channel for use when no MSU0500/0501s are configured
	MSF1026	Nonsimultaneous IOM Channel used when MSU0500s are configured
	MSF1027	Nonsimultaneous DATANET Channel used when MSU0500/0501s are configured
	MSA1027	Addressing Capability for four (4) MSU0400/0402/0451 units
	MSA1029	Addressing Capability for two (2) MSU0500/0501 units
MSP0605	MSF1037	Device Adapter for MSU0500
	MSF1038	Device Adapter for MSU/0402/0451
	MSF1046	MSU0501 Attachment Feature with Device Adapter (MSF1037) installed
	MSK6005	Upgrade Kit (from MSP0605 to MSP0602)
MSP0604/0607	MSF1040	Device Adapter for MSU0400/0402/0451
	MSF1047	Device Adapter for MSU0400/0402/0451 on MSP0604 only
	MSK6006	Upgrade Kit, MSP0604 to an MSP0608
	MSK6007	Upgrade Kit, MSP0607 to an MSP0609
	MSA1040	Addressing Capability for four MSU0400/0402/0451s
	MSA1041	Addressing Capability for two MSU0500/0501s

Table A-2 (Cont). Mass Storage Processor Options

Mass Storage Processor	Option	Description
MSP0604/0607/0608/0609	MSF1043	Nonsimultaneous (switched) DATANET Channel
	MSF1044	Nonsimultaneous (switched) IOM Channel
MSP0608/0609	MSA1042	Addressing Capability for MSU0400/0402/0451 (one per four MSUs)
	MSA1043	Addressing Capability for MSU0500 (one per two MSUs)
	MSF1041	Device Adapter for attachment of up to 16 MSU0400/0402/0451s for the MSP0609 only
	MSF1042	Drive Expansion for up to 7 additional MSU0500s
MSP0611	MSF1048	Device Adapter for attachment of up to 16 MSU0400/0402/0451s for the MSP0608 only
	MSF1140	Device Adapter for MSU0400/0402/0451
	MSA1140	Addressing Capability for four MSU0400/0402/0451s
MSP0612	MSA1141	Addressing Capability for two MSU0500/0501s
	MSK0612	Upgrade Kit, MSP0611 to MSP0612
	MSA1142	Addressing Capability for four MSU0400/0402/0451s
	MSA1143	Addressing Capability for two MSU0500/0501s
MSP0611/0612	MSF1141	Device Adapter for attachment of up to 16 MSU0400/0402/0451s (cannot be used with MSF1142)
	MSF1142	Drive Expansion for up to seven additional MSU0500/0501s (cannot be used with MSF1141)
	MSF1143	Nonsimultaneous (switched) DATANET channel
MSP0611/0612	MSF1144	Nonsimultaneous (switched) IOM channel
	MSF1150	Second nonsimultaneous DATANET channel
	PSS8001	Capacitor ridethrough option for MSP0611/0612/8002 and MTP0611

Table A-2 (Cont). Mass Storage Processor Options

Mass Storage Processor	Option	Description
MSP8000	MSF8000	Device Adapter for MSU0400/0402/0451, limit of 16 drives
	MSA8000	Addressing Capability for four MSU0400/0402/0451s
	MSA8001	Addressing Capability for two MSU0500/0501s
	MSK8000	Upgrade Kit, MSP8000 to MSP8001 (must replace MSF and MSAs with MSP8001 features)
MSP8001	MSF8001	Device Adapter for attachment of up to 16 MSU0400/0402/0451s
	MSA8002	Addressing Capability for four MSU0400/0402/0451s
	MSA8003	Addressing Capability for two MSU0500/0501s
MSP8000/8001	MSF8002	Nonsimultaneous DATANET Channel
	MSF8003	Nonsimultaneous IOM Channel

Mass Storage Subsystem Configurations

The configurations for each mass storage subsystem are shown in Tables A-3 through A-8.

Table A-3. MSP0602/0603 Mass Storage Processor Configurations

Mass Storage Units	Maximum Units	
	Single Channel	Dual Channel
MSU0400	32	16
MSU0402	32	16
MSU0451	32	16
MSU0500	8	0
MSU0501	8	0
Mixed combinations:		
MSU0400/0402/0451s and MSU0500/0501s	Up to 16 and Up to 8	0

Table A-4. MSP0605 Mass Storage Processor Configurations

Mass Storage Units	Maximum Units		
MSU0400	8		
MSU0402	8		
MSU0451	8		
MSU0500	4		
MSU0501	4		
Mixed combinations: MSU0400/0402/0451s and MSU0500/0501s	5 or 6 and 1	3 or 4 and 2	1 or 2 and 3

Table A-5. MSP0604/0607/8000/8001 Mass Storage Processor Configurations

Mass Storage Units	Maximum Units						
MSU0400	16						
MSU0402	16						
MSU0451	16						
MSU0500	8						
MSU0501	8						
Mixed units: MSU0400s MSU0402s MSU0451s and MSU0500s MSU0501s	13 or 14 and 1	11 or 12 and 2	9 or 10 and 3	7 or 8 and 4	5 or 6 and 5	3 or 4 and 6	1 or 2 and 7

Table A-6. MSP0609 Mass Storage Processor Configurations

Mass Storage Units	Maximum Units
MSU0400	16
MSU0402	16
MSU0451	16
MSU0500	15
MSU0501	15
Mixed combinations: MSU0400/0402/0451s and MSU0500/0501s	16 MSU0400/0402/ 0451s and 8 MSU0500/0501s

Table A-7. MSP0611 Mass Storage Processor Configurations

Mass Storage Units	Maximum Units
MSU0400	16
MSU0402	16
MSU0451	16
MSU0500	8
MSU0501	8
Mixed combinations:	up to 16 spindles (each MSU0400/0402/0405 provides one spindle, each MSU0500/0501 provides two spindles)

Table A-8. MSP0612 Mass Storage Processor Configurations

Mass Storage Units	Maximum Units/Module
MSU0400	16
MSU0402	16
MSU0451	16
MSU0500	15
MSU0501	15
Mixed combinations: MSU0400/0402/0451s and MSU0500/0501s	16 MSU0400/0402/0451s and 8 MSU0500/051s

Controls and Indicators

The operator control panel, located on the top of the Mass Storage Processor for freestanding units or in the Integrated Control Unit for integrated versions, contains the controls and indicators required for normal operation of the MSP. Refer to Figures A-2 and A-3 respectively. A description of each push button/indicator is given in Table A-9.

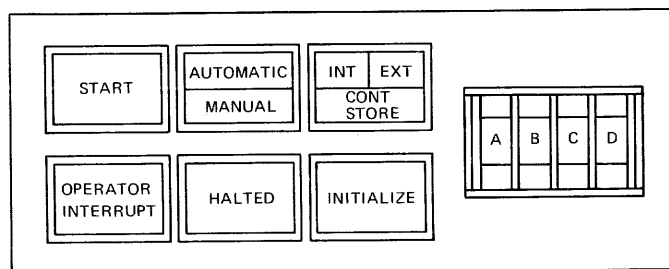

Figure A-2. Integrated Mass Storage Processor Control Panel

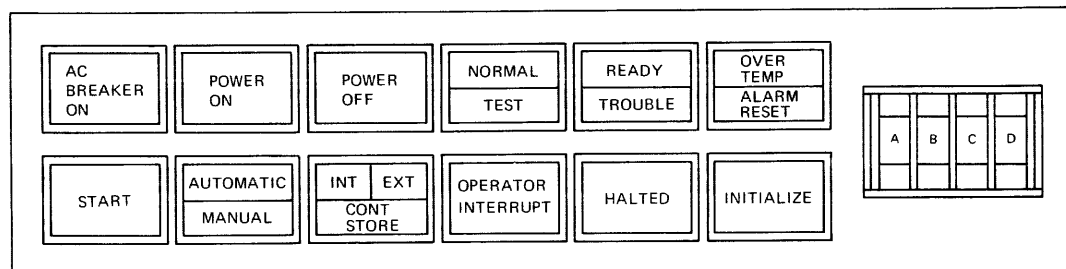

Figure A-3. Freestanding Mass Storage Processor Control Panel

Table A-9. Mass Storage Processor Controls and Indicators

Push Button/Indicator	Function
<i>All Processors</i>	
START	Pressing this button when the control/processor is in the HALTED state changes it from the TROUBLE state to the READY state (see READY/TROUBLE indicator) and the indicator lights white.
AUTOMATIC/MANUAL	This split-field indicator identifies the operational mode (green = AUTOMATIC, blue = MANUAL) of the control/processor. The button allows the operator to control the execution of the initialize and halt options of the microprogram. These options are logically enabled in the MANUAL mode. Pressing this button changes the state of the switch.

**Table A-9 (Cont). Mass Storage Processor
Controls and Indicators**

Push Button/Indicator	Function
INT/EXT/CONT STORE	<p>This three-way split-field indicator lights red in the individual field when an error is detected. Pressing this button or executing the microprogram's error option should reset the error and turn off the indicator light. If the error persists, notify Honeywell Customer Services.</p> <p>EXT — Indicates an error detected during a device adapter interface or main memory operation.</p> <p>INT — Indicates an error detected internal to the processing structure of the processor (internal buses, etc.)</p> <p>STORE — Indicates an error detected during the access of a microprogram from processor store.</p>
OPERATOR INTERRUPT	<p>Pressing this button lights the indicator (white) and causes the execution of a special interrupt that transfers the information stored in the ADDRESS/SIMULATE switches to the central system. The OPERATOR INTERRUPT state is reset by the microprogram and the indicator goes out.</p>
HALTED	<p>This indicator lights blue when the control/processor goes into the halted state.</p>
INITIALIZE	<p>Pressing this button lights the HALTED indicator and resets the control/processor to the initialized state. The indicator lights white.</p>
Address Simulate	<p>These four thumbwheel switches, used in conjunction with the maintenance panel switches, permit the user to address various functions of the control/processor, depending upon the specific application required. These switches are used mainly by Customer Services in conjunction with the maintenance panel to diagnose the control/processor. Do not change the state of these switches while they are being sensed by the microprogram.</p> <p><i>The remaining indicators/push buttons are for the freestanding processors only (see Figure A-3).</i></p>
AC BREAKER ON	<p>This indicator lights red when the cabinet circuit breaker is on and power is being applied to it from its power source panel.</p> <p>Note: The cabinet circuit breaker is located behind the right front door at the bottom right side of the cabinet on the CKP panel. This circuit breaker applies primary service power to the cabinet and protects it from overloads.</p>

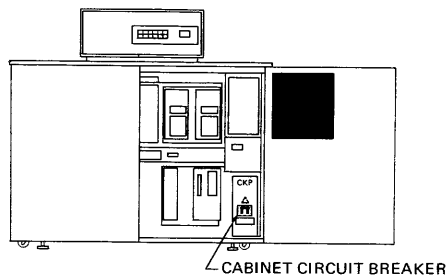

**Table A-9 (Cont). Mass Storage Processor
Controls and Indicators**

Push Button/Indicator	Function
POWER ON	Pressing this button when ac power is on (AC BREAKER ON indicator lit) turns the cabinet dc power on. The POWER ON indicator lights yellow and the POWER OFF indicator goes out.
POWER OFF	Pressing this button when dc power is on turns the dc power off. The POWER OFF indicator lights green and the POWER ON indicator goes out.
NORMAL/TEST	<p>This split-field indicator identifies the state (green = NORMAL, yellow = TEST) of the MAINT PANEL MODE NORMAL/TEST switch located on the TEST area of the maintenance panel. The switch must be in the NORMAL state for online operation.</p> <p>Note: The maintenance panel is concealed behind the cover surrounding the operator panel. If the switch is in the TEST position, the operator may open the cover and reset the switch to NORMAL.</p>
READY/TROUBLE	<p>This split-field indicator identifies the operational state (green = READY, red = TROUBLE) of the control/processor.</p> <p>Note: The trouble state exists when the HALTED indicator is on or when the OPERATIONAL MODE OFFLINE/ONLINE switch located on the test area of the maintenance panel is set to OFFLINE. If the HALTED indicator is on, the operator may attempt to set the control/processor to the READY state by using the START switch. If it does not leave the HALTED state, open the maintenance panel cover and check and reset the OFFLINE/ONLINE switch to ONLINE if needed. If the trouble persists, the operator should notify Honeywell Customer Services.</p>
OVER TEMP/ ALARM RESET	This split-field push button/indicator lights red in the OVER TEMP field and white in the ALARM RESET field. The cabinet audible alarm sounds if the cabinet gets too warm. Pressing the switch turns off both the audible alarm and the white ALARM RESET indicator. The operator should press the POWER OFF switch and wait for the cabinet to cool before switching power back on. If the overtemperature condition continues, notify Honeywell Customer Services.

HONEYWELL INFORMATION SYSTEMS
Technical Publications Remarks Form

TITLE

LARGE SYSTEMS
MSU0402/0451
MASS STORAGE UNITS
OPERATION

ORDER NO.

AT71-03

DATED

OCTOBER 1982

ERRORS IN PUBLICATION

Large empty rectangular box for reporting errors in the publication.

SUGGESTIONS FOR IMPROVEMENT TO PUBLICATION

Large empty rectangular box for providing suggestions for improvement to the publication.



Your comments will be investigated by appropriate technical personnel and action will be taken as required. Receipt of all forms will be acknowledged; however, if you require a detailed reply, check here.

FROM: NAME _____

DATE _____

TITLE _____

COMPANY _____

ADDRESS _____

CUT ALONG LINE

PLEASE FOLD AND TAPE—
NOTE: U. S. Postal Service will not deliver stapled forms



NO POSTAGE
NECESSARY
IF MAILED
IN THE
UNITED STATES

BUSINESS REPLY MAIL
FIRST CLASS PERMIT NO. 39531 WALTHAM, MA02154

POSTAGE WILL BE PAID BY ADDRESSEE

HONEYWELL INFORMATION SYSTEMS
200 SMITH STREET
WALTHAM, MA 02154

ATTN: PUBLICATIONS, MS486

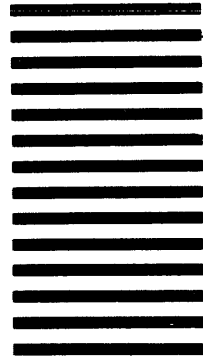

CUT ALONG LINE

FOLD ALONG LINE

FOLD ALONG LINE

Honeywell

Honeywell

Honeywell Information Systems

In the U.S.A.: 200 Smith Street, MS 486, Waltham, Massachusetts 02154
In Canada: 155 Gordon Baker Road, Willowdale, Ontario M2H 3N7
In the U.K.: Great West Road, Brentford, Middlesex TW8 9DH
In Australia: 124 Walker Street, North Sydney, N.S.W. 2060
In Mexico: Avenida Nuevo Leon 250, Mexico 11, D.F.

35809, 1182, Printed in U.S.A.

AT71-03